



INSTALLATION GUIDE

Delta Amphibia



www.deltamembranes.com



Contents

1.	Delta Amphibia overview	1
1.1	Delta Amphibia overview	1
1.2	Benefits of Delta Amphibia	1
1.3	Technical Data	1
1.4	Typical Fields of Application	1
1.5	Surface Preparation and Application	2
1.6	Radon and Methane	2
2.	Technical Information - Delta Amphibia 1.3mm	3
3.	Site preparation	5
4.	Application Overview	10
4.1	Foundation Piles	11
4.2	Lift Pit	12
4.3	Application on Raft Foundation Toe	13
5.	Application Overview	14
5.1	Corner 90°	14
5.2	Corner 90°	15
5.3	Corner 90°	16
5.4	Presence of de-watering wells and different heights	17
5.5	Sheet Application	18
5.6	Joints in Raft Foundation	19
5.7	Joints in Raft Foundation	20
5.8	Vertical Application on Formworks	21
5.9	Vertical Application on Diaphragm Walls	22
5.10	Vertical Application on Metal Sheet Piling	23
5.11	Vertical Application on Pile Walls	24
5.12	Joints in Retaining Walls	25
5.13	Slab Sealing in Blindside Installation	26
6.	Service of Penetrations	27
6.1	Sealing of Penetration	27
6.2	Sealing of Penetration	28
6.3	Connections and Sealing Details	29
7.	Maintenance	30
8.	Patch Repair during installation	30
9.	Inspection/Quality Control	30
10.	Health and Safety	30
11.	Warranty/Guarantees	30
12.	Troubleshooting	30
13.	Ancillaries	31
14.	Site Log	32
15.	Technical Drawings	33



Delta Amphibia Overview

1.1 Delta Amphibia Overview

Delta Amphibia is a 1.3mm BBA Approved pre- and post- applied fully bonded waterproofing membrane.

Delta Amphibia is a unique Self-Healing/Repairing, Self-Sealing, fully bonded Type A waterproofing membrane, utilising its advanced Reactive Core technology, Delta Amphibia will not only Self-Repair in the event of accidental puncture and Self-Heal, but will also Self-Seal.

Delta Amphibia is a pre- and post-applied waterproofing membrane which can be installed horizontally and vertically in all Type A waterproofing applications.

The unique properties of Delta Amphibia are achieved through four active layers – a watertight barrier, Reactive Core which allows Delta Amphibia to Self-Seal and Self-Heal in the event of accidental damage, an active barrier with the ability to Self-Seal at overlaps resisting lateral movement of water and a strong bonding layer.

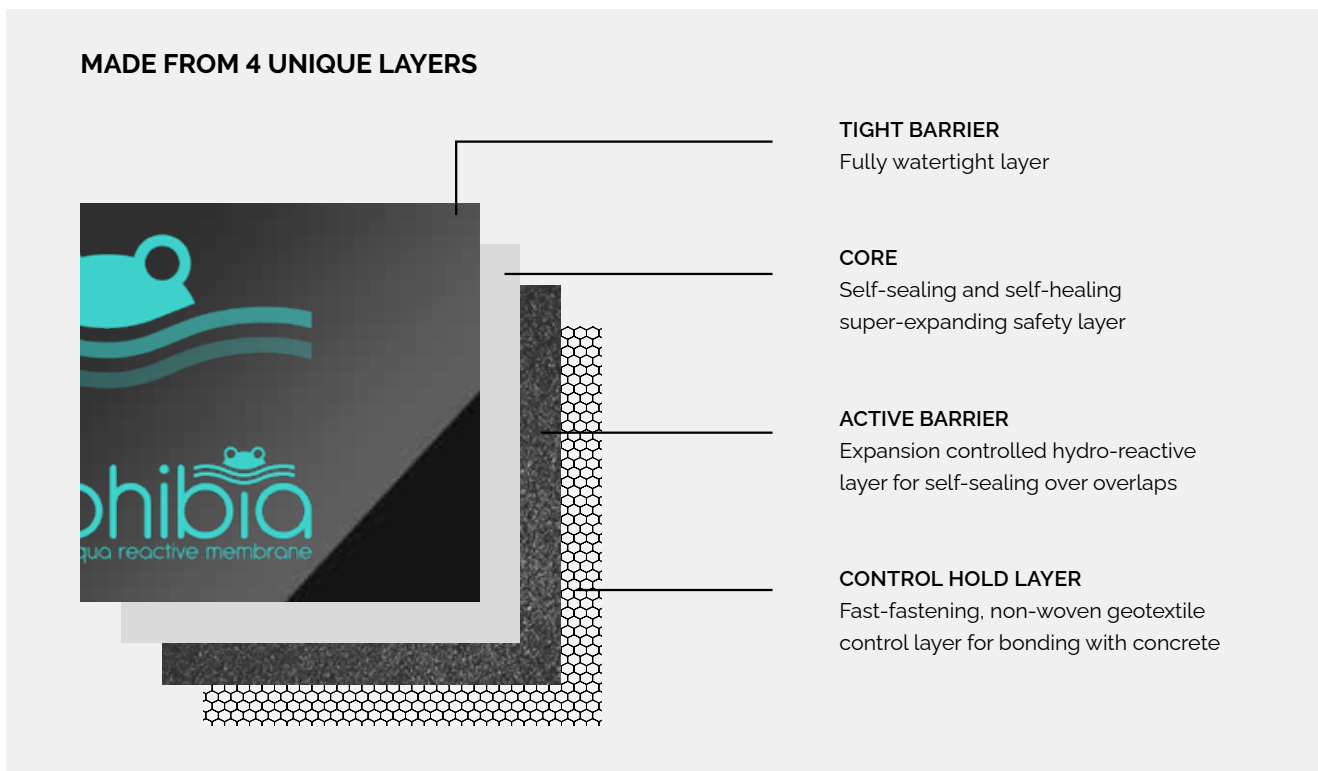

Pre-applied bonded membranes are used to waterproof concrete in basements and below ground structures on the positive side (outside). They are installed before the reinforcement underneath a base slab and vertically on a soil retention system, or in a formwork.

The unique Self-Repairing function of Delta Amphibia protects structures from water and moisture permeability in the event of accidental puncture. Delta Amphibia's unique Self-Repairing function is activated in the event of Delta Amphibia being damaged.

Delta Amphibia's Active Core offers continuous protection at overlaps. Delta Amphibia has excellent crack-bridging capabilities at places where cracks may occur. When pre-applied (before the concrete pour), the wet concrete is absorbed into Delta Amphibia's fleece Bond Layer, integrally bonding Delta Amphibia to concrete.

1.2 The benefits of Delta Amphibia

- Active protection for watertight waterproofing
 - Self-Repairing
 - Self-Sealing
 - Self-Healing
 - Self-Fastening
- Vertical or Horizontal application
- Absolute impermeability with no side seepage of water
- Immediate mechanical protection, self-repairing also on accidental puncture
- High resistance to hydraulic load

High flexibility and capacity to bridge cracks

- Full mechanical bond to concrete
- Extremely flexible – Resistant to movement and fissures in substrates

Delta Amphibia satisfies all grades of waterproofing in accordance with BS 8102:2022, Table 2 as Type A, Barrier Protection System in accordance with section 8, Type A (Barrier) Protection – Sub Section 8.2.4, Active Core Liners and Table 3, Waterproofing Barriers.

1.5 Surface Preparation and Application

Product	Definition	Type of Protection	Fields of Application
Delta Amphibia Safety Tape	Adhesive tape to protect overlaps	Acrylic Adhesive + Film	In foundation beds with Delta Amphibia application before concreting and in post application on walls.
Delta Amphibia Safety Tape BT	Double-sided butyl tape to protect overlaps	Butyl adhesive on both sides + film	In combination with Delta Amphibia Lap Seal in case of Delta Amphibia membrane used against the entry of gases.
Delta Amphibia Grip Tape	Double-sided butyl tape self-fastening to concrete to join overlaps	Butyl adhesive + film with TNT	As an alternative to Delta Amphibia Safety Tape for Delta Amphibia applications before concreting to achieve a higher continuity of adhesion to concrete in case of close overlaps or where specifically required (see national/ local regulations) On walls with Delta Amphibia pre-applied in formwork, as an alternative or in combination with staples before concreting
Delta Amphibia Lap Seal	Double-sided Butyl Tape for Overlaps Gastightness	Butyl Adhesive + Film	To complete Delta Amphibia in case of use against the entry gases, in particular radon and methane, in combination with Delta Amphibia Safety Tape BT (see double taping fig.6)
Delta Amphibia Bi-Mastic (See related Technical Data Sheet)	High Performance Deformable Adhesive Mastic	Modified Silanol Adhesive	On walls with Delta Amphibia application against retaining wall structures and wherever a tenacious adhesion of the overlaps is required before concreting. On walls with Delta Amphibia applied inside formwork, as an alternative or in combination with staples before concreting

1.3 Technical Data

Delta Amphibia 1.3mm		
Specification	1.8m x 20m	0.9m x 10m
Roll Dimensions	1.8m x 20m (70.87 x 787.40in)	0.9m x 10m (35.43 x 393.70in)
Equivalent Area	36 ² m (387.5 ft ²)	9 m ² (96.9 ft ²)
Roll Weight	47kg (104lbs)	12kg (26lbs)
Tolerance	+/- 5%	+/- 5%

1.4 Typical fields of application

- Type A Waterproofing solution for below ground and earth-retained structures
- Delta Amphibia may be used in all applications, where reinforced concrete structures require protection against groundwater and contaminants
- Used for water pressure-tight surface sealing of WU concrete structures
- External barrier, for the waterproofing and protection of floor slabs and exterior concrete wall surfaces against soil moisture
- Foundations
- Basements
- Tunnels
- Retaining Walls

Delta Amphibia Overview

1.6 Radon and Methane

Gas Radon

The presence of gas (methane and radon) in the soil can be a relevant problem for underground structures. In particular, Radon is a radioactive gas naturally occurring in the ground. There is a higher concentration of radon if the house is above or near granitic or volcanic land, especially if its foundations are resting directly on the ground. What can be done about it? Once ascertained that the radon level in the house is higher than average – radon is also present in upper floors, but it decreases with height – you need to reduce its hazard. Soil depressurisation, forced ventilation in crawl spaces, foundation waterproofing, crack sealing as well as ventilation of rooms can be carried out to face the issue.

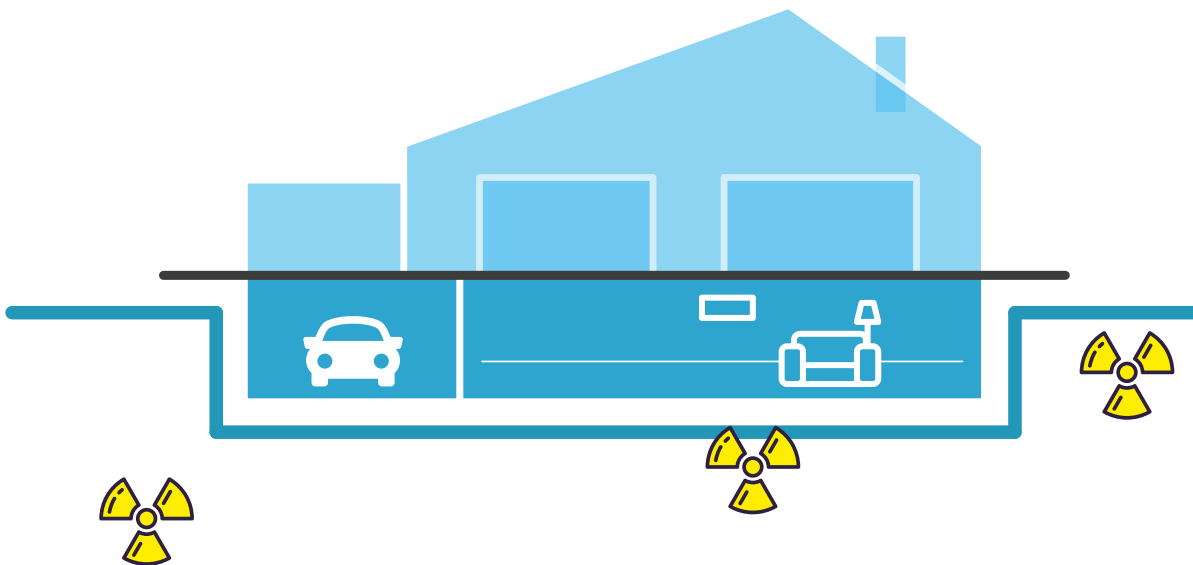

Radon & underground structures

Radon is an inert gas, which means that it does not chemically react with the environment around it. Once generated, it can migrate through the soil and spread from construction materials. The concentration of radon in a house depends on many factors: the presence of uranium and radium in the soil and in construction materials, soil permeability, construction techniques and living habits. The pressure inside buildings is generally lower than outside. The lower pressure influences the normal convective motion of the soil, so that radon is 'drawn' inside the buildings themselves, penetrating through different areas: cracks in the foundation bed or vertical walls, construction joints in the horizontal and vertical connection points, bed interruptions or drains.

In this sense, both in new buildings and in underground structures to be refurbished, at the design stage it is best to provide for vents, construction joints, cracks and drains.

In this way the Delta Amphibia system can be considered a protection against gas ingress in the structures reducing risks for health.

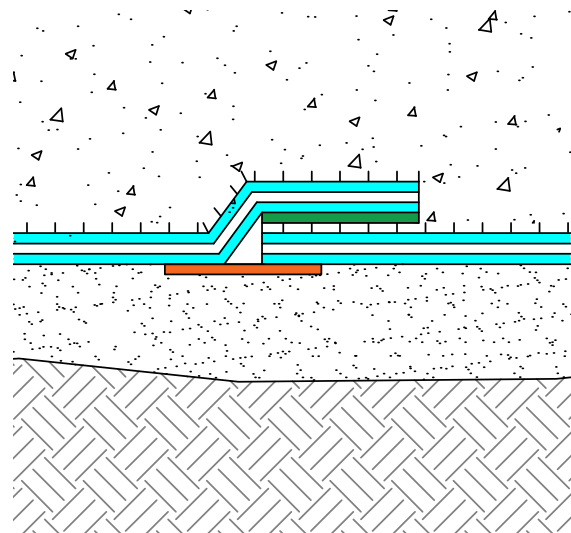

TECHNICAL INFORMATION

2. Delta Amphibia 1.3mm



Description

Delta Amphibia is a 1.3mm BBA Approved pre- and post- applied fully bonded waterproofing membrane with reactive core, this hydro-reactive, self-healing, self-sealing multi-layer waterproofing system can be applied on vertical and horizontal areas of new construction.

A Type A (Barrier Protection) co-extruded multi-layer waterproofing membrane.

This robust, tough but flexible waterproofing system is ideal for all construction applications. Uniquely composed of three layers of unequalled features such as Tight Barrier (watertight layer), Core (self-sealing and self-repairing expansive safety layer, even in the event of puncture), and Active Barrier (a hydro-reactive layer with controlled expansion, which prevents lateral water seepage and seals at overlaps).

Delta Amphibia 1.3mm offers differentiated function for total water tightness of underground structures against water seepage. Moreover, it is provided with a calibrated non-woven fabric on the inner face/side in contact with fresh concrete which allows the mechanical adhesion of the membrane to the structure. Suitable for horizontal or vertical applications and for all ground floor and basement construction including lift pits, raft foundations, open basement excavation, sealing on internal formworks, construction joints, sheet piles, micropiles and service penetrations. Delta Amphibia 1.3mm is available in two widths 0.9m (900mm) or 1.8m (1800mm) for ease of use depending on area for detailing.

Features

- BBA Approved
- High performance external waterproofing membrane
- Uniquely self-sealing, self-healing and self-repairing
- Absolute impermeability with no lateral seepage of water
- Immediate mechanical protection
- High flexibility and capacity to bridge cracks
- Total adhesion to reinforced concrete structures

Product Details

DMS 1035 - 0.9m x 10m
DMS 1036 - 1.8m x 20m

Technical Data

Delta Amphibia 1.3mm		
Specification	1.8m x 20m	0.9m x 10m
Roll Dimensions	1.8m x 20m (70.87 x 787.40in)	0.9m x 10m (35.43 x 393.70in)
Equivalent Area	36 ² m (387.5 ft ²)	9 m ² (96.9 ft ²)
Roll Weight	47kg (104lbs)	12kg (26lbs)
Tolerance	+/- 5%	+/- 5%



SITE PREPARATION

3. Site Preparation

Delta Amphibia Membranes and System Components should be installed in accordance with the recommendations of the relevant codes of practice and industry guidance, such as BS 8102:2022 Protection of below ground structures against water ingress. Code of practice. and CP 102:1973 Code of practice for protection of buildings against water from the ground.

Type A waterproofing is defined by BS 8102:2022 as 'barrier protection'. Providing protection against ground water ingress by applying a waterproof material to the external walls and floor slabs of a below ground structure forming a barrier between the structure and any groundwater present.

British Standard BS 8102:2022, Section 8, in particular, places emphasis on the design and specification of Type A "barrier protection", in particular the importance of continuity of the waterproofing protection.

Delta Amphibia a pre or post applied, Type A waterproofing system.

Fully bonded systems, such as the Delta Amphibia System can be distinguished according to their time of installation into pre- and post- applied. Pre-applied bonded systems are installed before the concrete works on a mud-slab, a soil retention system, or a formwork and later form a bond with the subsequently poured fresh concrete. They can be installed in horizontal formation, with the concrete structure being built directly on top. These systems require special care on site since no additional protection layers are applied. Further concrete works on pre-applied membranes can lead to soiling and punctual damage, eventually affecting the bond or the waterproofing system.

Post applied systems are installed onto existing hardened concrete structures.

Correct substrate preparation of concrete surfaces is essential in creating a full and durable bond to prevent any water migration or lateral water underflow between the concrete structure and the Delta Amphibia System.

Surfaces that are to be waterproofed can be damp, and must not have any large protrusions, cavities or continuous water flows that could compromise the continuity and sealing process of membrane overlaps.

Surfaces must be prepared prior to application and be free from contamination such as adhesives, coatings, curing compounds, dust, grease, oils, and any other material that could compromise adhesion.

Any stagnant water should be removed prior to installation of the Delta Amphibia membranes.

Delta Amphibia membranes must be installed with the Bonding layer (fleece) to be in direct contact with the structural concrete when it is cast. The Bonding layer is easily identifiable due to its grey fleece like texture.

Overlaps of Delta Amphibia should be least 250 mm from each construction joint.

Installation checklist:

- Substrate surfaces are uniform
- Substrate surfaces are free from oil, grease, dust, curing compounds, adhesives, and coatings
- Voids, protrusions, and cavities must be filled before installation
- Substrates can be damp or slightly wet, no ponding water
- Substrate temperature has to be a minimum of +5°C

Sheets of Delta Amphibia membrane can be folded and cut in any direction.

Detailing is an essential process for successful installation of the Delta Amphibia system and Type A waterproofing. All service penetrations should be fully sealed and included in the detailed planning. Delta Amphibia overlap joints and other detailing connections should be sealed with Delta Amphibia AKTI-VO 201, Delta Bi Mastic and Delta Amphibia Safety Tape.

Particular attention should be given to:

- Penetrations through the waterproofing system
- Fixings, where these are necessary
- Application over joints in the substrate
- Compatibility, durability, and buildability; and
- The need for membranes to be fully bonded to both prevent lateral migration (tested to BS EN 1928 Method A) and resist negative hydrostatic head (tested to DIN 1048/BS EN 1542).

The water tightness of a Type A System relies fundamentally on the effectiveness of the waterproofing system, site and design preparation, installation of the membrane system and the structure.

A risk assessment should be carried out to identify any possible long-term water pressures, the effects of surface water percolation, use of external drainage and the effects of party wall impaction on neighbouring structures.

Delta Amphibia Membranes can be positioned in a variety of different situations as part of a combined system, for example:

- Externally to new formed concrete
- Between contiguous or secant piles and a concrete liner wall
- Externally in combination with a Type B Waterproof concrete system
- Beneath basement and ground bearing slabs
- In combination with an internal Type C Delta Cavity Drainage Membrane System
- As an effective external system for lift pits and service trenches

Delta Amphibia membranes cannot be thermally joined.

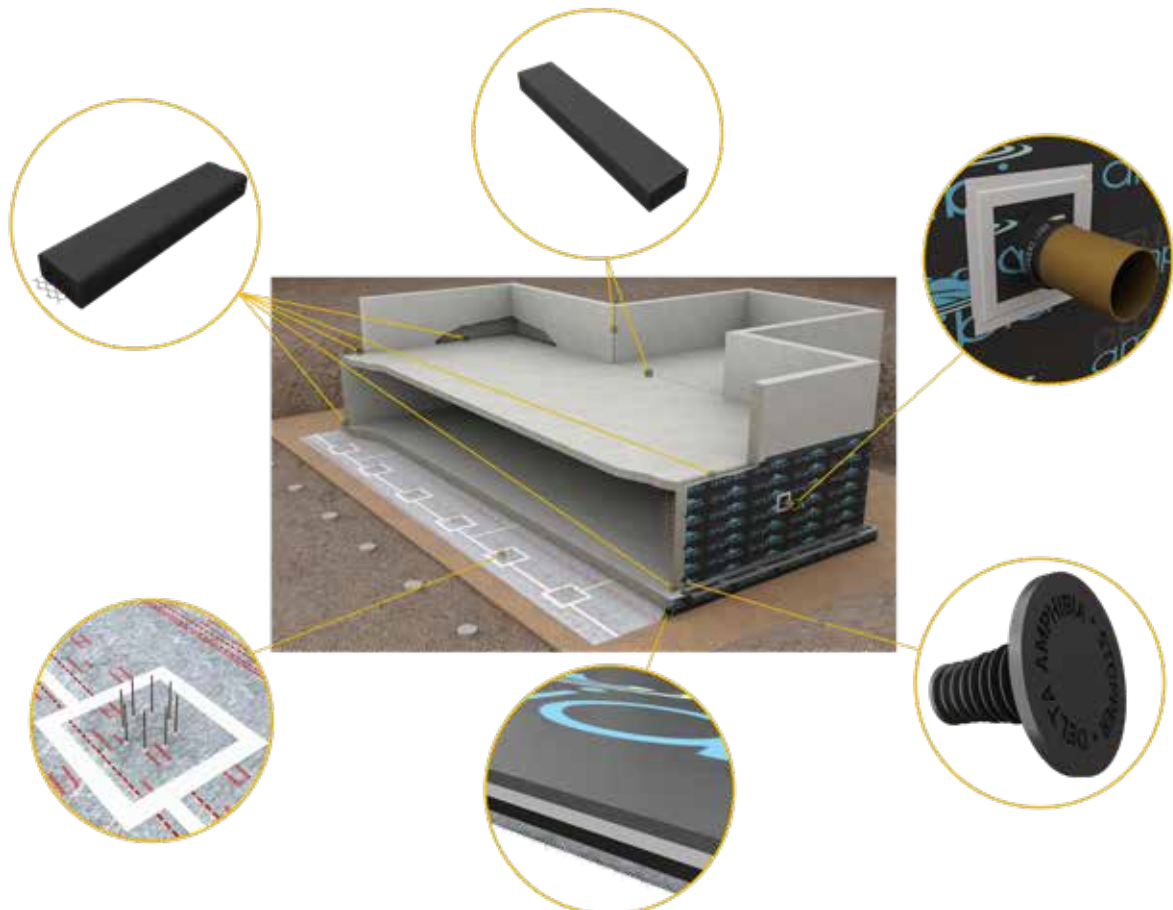

APPLICATION

4. Overview

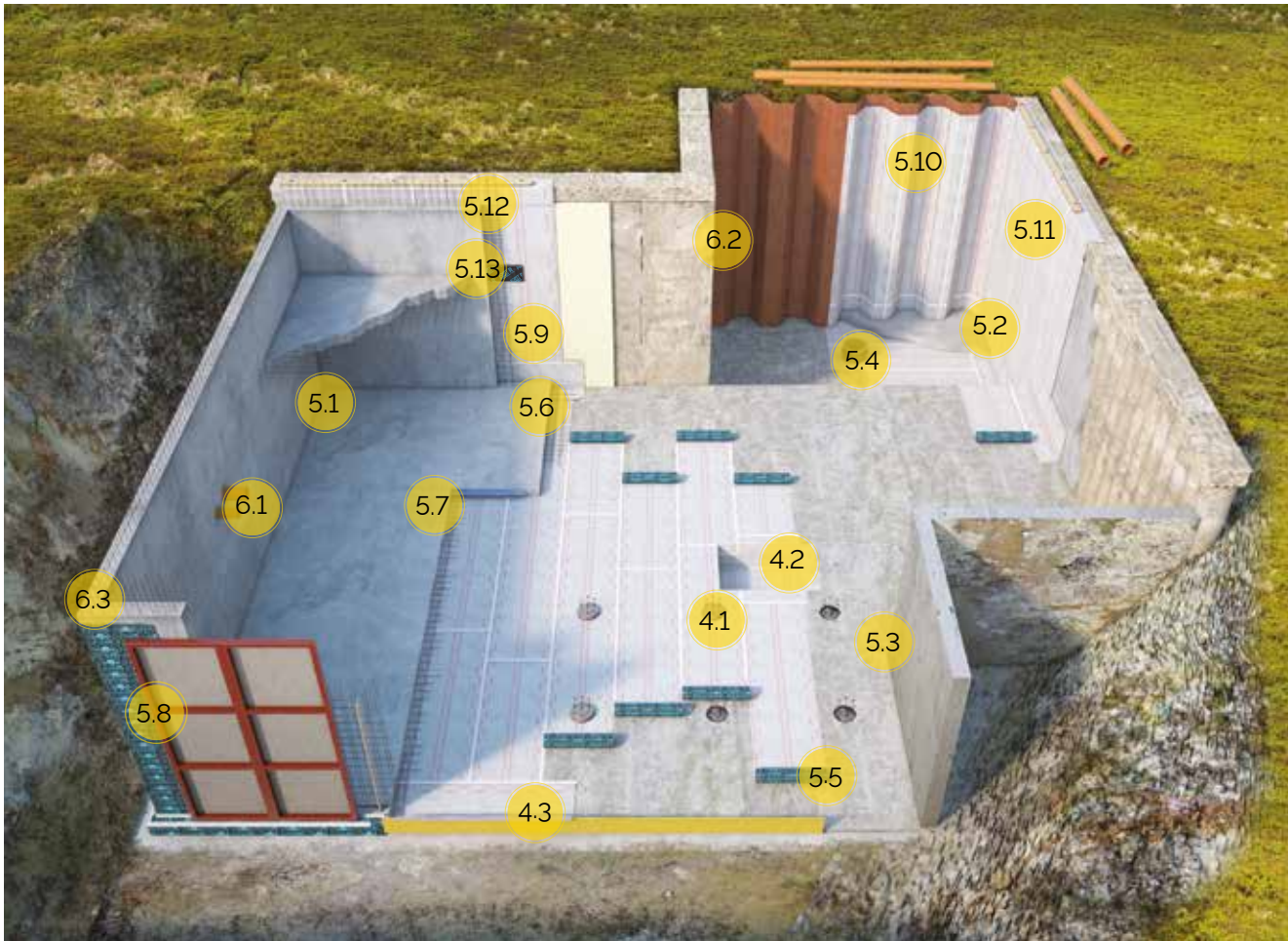

Delta Amphibia fully bonded membranes must be in direct contact with fresh concrete over the entire Bonding area, to ensure a full surface bond which will prevent lateral water migration. Please refer to relevant sections of this Installation Guide for guidance on the below applications.

Application

- 4.1 Foundation Piles
- 4.2 Lift Pit
- 4.3 Application on Raft Foundation Toe

- 5.1 Corner 90°
- 5.2 Corner 90°
- 5.3 Corner 90°
- 5.4 Presence of de-watering wells and different heights
- 5.5 Sheet Application
- 5.6 Joints in Raft Foundation
- 5.7 Joints in Raft Foundation
- 5.8 Vertical Application on Formworks
- 5.9 Vertical Application on Diaphragm Walls
- 5.10 Vertical Application on Metal Sheet Piling
- 5.11 Vertical Application on Pile Walls
- 5.12 Joints in Retaining Walls
- 5.13 Slab Sealing in Blindside Installation

Service of penetrations

- 6.1 Sealing of Penetration
- 6.2 Sealing of Penetration
- 6.3 Connections and Sealing Details

APPLICATION

4.1 Foundation Piles

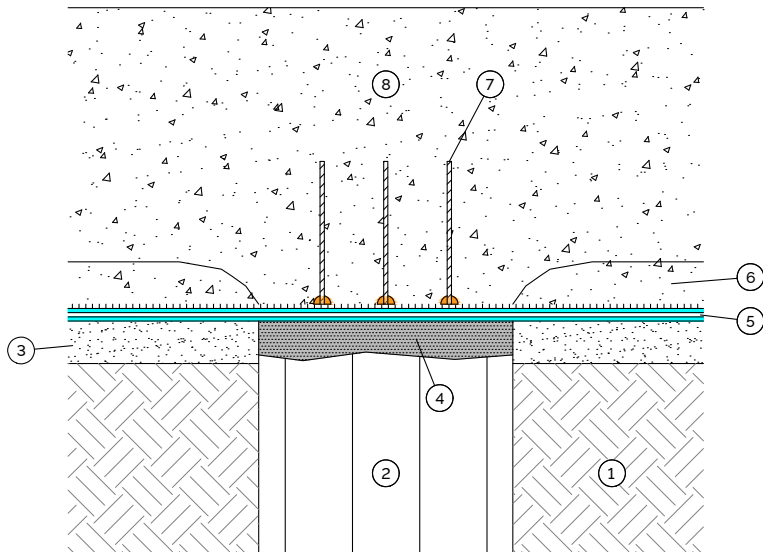
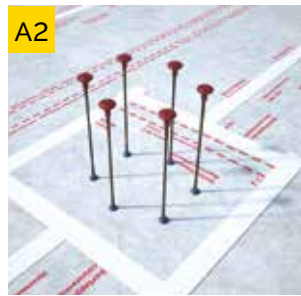
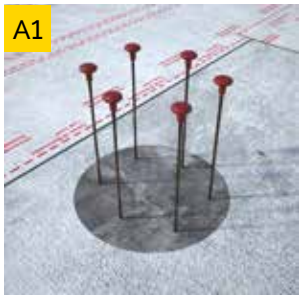

A1/A2

Delta Amphibia over pile heads

1. Soil
2. Foundation pile
3. Lean concrete
4. Reconstruction with Koster Repair Mortar Plus
5. Delta Amphibia over pile heads
6. Concrete protective screed (optional)
7. Steel bars sealed with Delta Amphibia AKTI-VO 201
8. RC structure suitable to withstand hydraulic pressures and exempt from defects

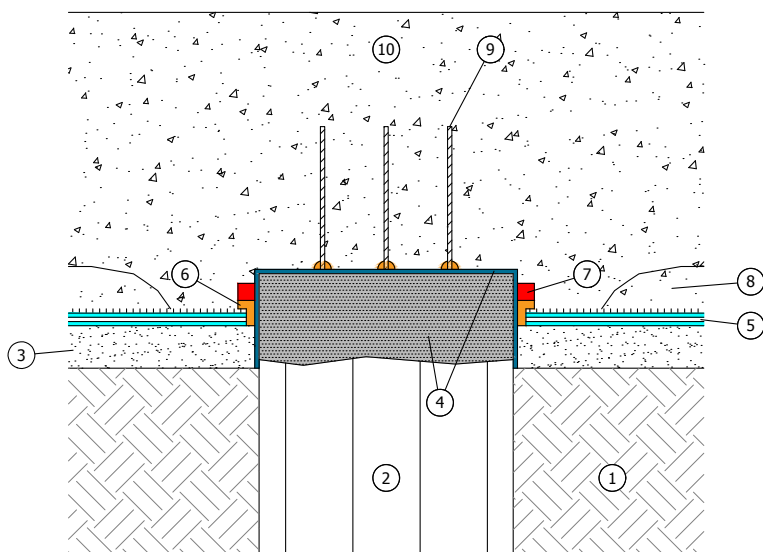
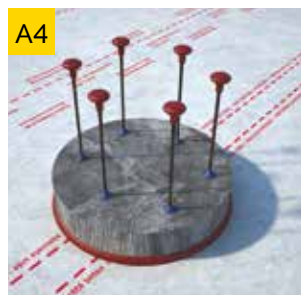

A3/A4

1. Soil
2. Foundation pile
3. Lean concrete
4. Suitable reconstruction with Koster Repair Mortar Plus or with concrete externally waterproofed with Koster NB1
5. Delta Amphibia
6. Delta Amphibia AKTI-VO 201
7. Delta Amphibia WT Range (hydro-expansive waterstop)
8. Concrete protective screed (optional)
9. Steel bars sealed with Delta Amphibia AKTI-VO 201 or Delta Amphibia WT Expansion
10. RC structure suitable to withstand hydraulic pressures and exempt from defects

APPLICATION

4.2 Lift Pit

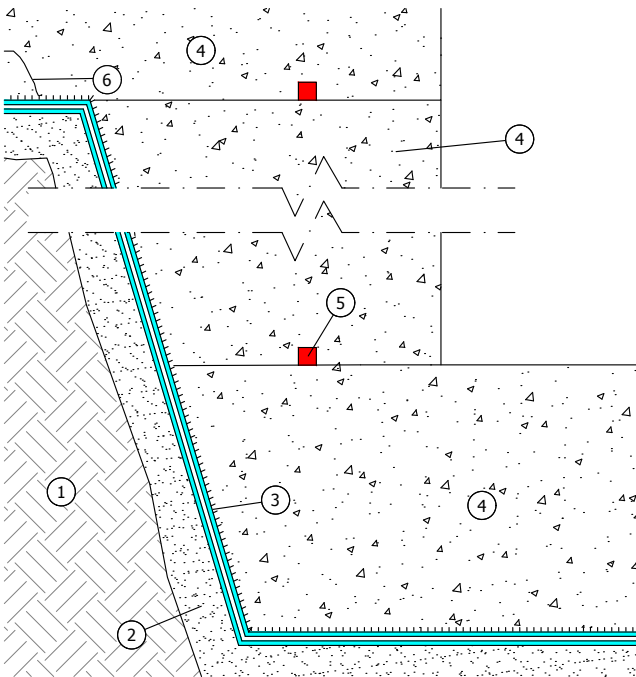

B1/B2/B3/B4

Lift pit

1. Soil
2. Lean concrete
3. Delta Amphibia
4. RC structure suitable to withstand hydraulic pressures and exempt from defects
5. Delta Amphibia WT Range (hydro-expansive waterstop)
6. Concrete protective screed (optional)

Lift pit with Delta Amphibia system



APPLICATION

4.3 Application on Raft Foundation

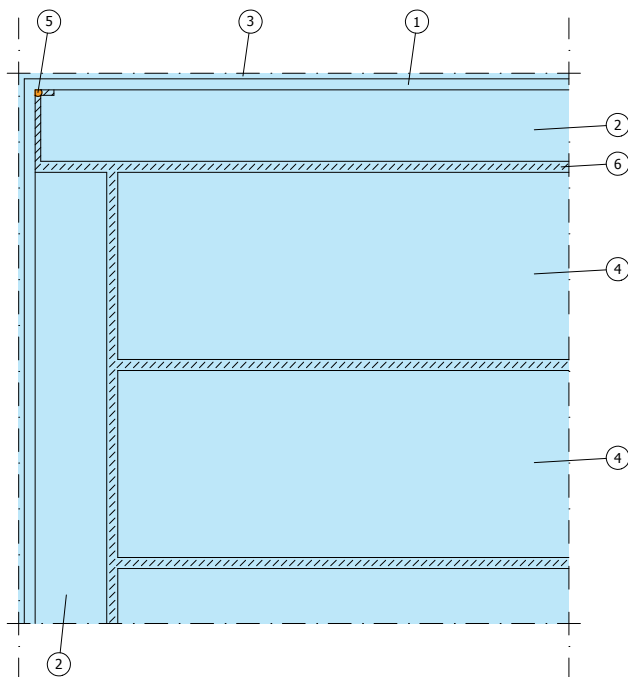

C1/C2

Open basement excavation

1. Formworks
2. Delta Amphibia vertically installed all along the formworks and folded on the raft foundation.
3. Delta Amphibia flap over the formwork
4. Delta Amphibia on lean concrete
5. Delta Amphibia AKTI-VO 201
6. Delta Amphibia Safety Tape or Delta Amphibia BI-Mastic pressures and exempt from defects

Raft Foundation with Delta Amphibia system



APPLICATION

5.1 Corner 90° - Open Basement Excavation

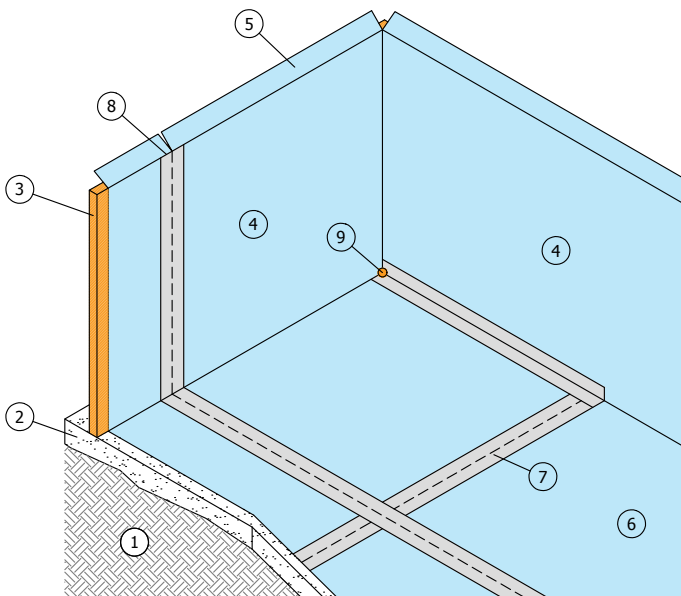

D1.1/D1.2/D1.3/D1.4

Sealing of internal 90° corner on Formworks

1. Soil
2. Lean concrete
3. Formwork
4. Delta Amphibia vertically applied all along the formworks and folded on the raft foundation
5. Delta Amphibia flap over the formwork
6. Delta Amphibia on lean concrete
7. Delta Amphibia Safety Tape or Delta Amphibia BI-Mastic
8. Apply staples to fix vertically the sheets to the formworks
9. Delta Amphibia AKTI-VO 201

90° corner in case of open basement excavation with Delta Amphibia system



APPLICATION

5.2 Corner 90° - Application on Raft Foundation

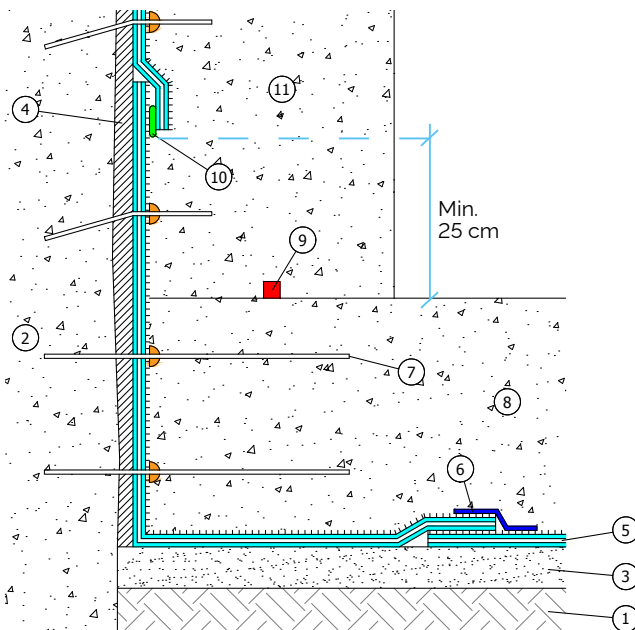

D2.1/D2.2/D2.3/D2.4/D2.5

Sealing of internal 90° corner on diaphragm walls

1. Soil
2. Diaphragm walls
3. Lean concrete
4. Smoothing or non-degradable rigid panel
5. Delta Amphibia
6. Delta Amphibia Safety Tape or Delta Amphibia BI-Mastic
7. Connectors sealed with Delta Amphibia AKTI-VO 201
8. RC raft foundation suitable to withstand hydraulic pressures and exempt from defects
9. Delta Amphibia WT Range (hydro-expansive waterstop)
10. Delta Amphibia BI-Mastic
11. RC walls suitable to withstand hydraulic pressures and exempt from defects

90° corner in case of blindside application with Delta Amphibia system



APPLICATION

5.3 Corner 90° - Open Basement Excavation

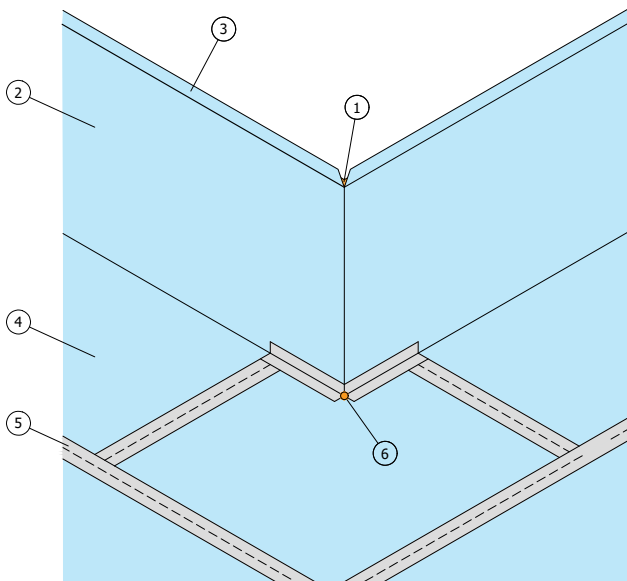
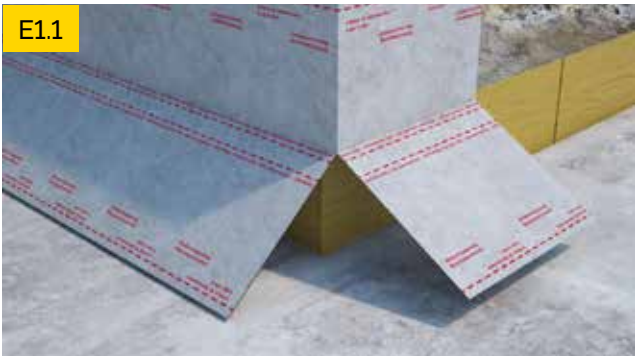

E1.1/E1.2/E1.3/E1.4/E1.5

Sealing of internal 90° corner on formworks

1. Formwork
2. Delta Amphibia vertically applied all along the formworks and folded on the raft
3. Delta Amphibia flap over the formwork
4. Delta Amphibia on lean concrete
5. Delta Amphibia Safety Tape or Delta Amphibia BI-Mastic
6. Delta Amphibia AKTI-VO 201

270° corner in case of open basement excavation with Delta Amphibia system



APPLICATION

5.4 Presence of dewatering wells and different heights

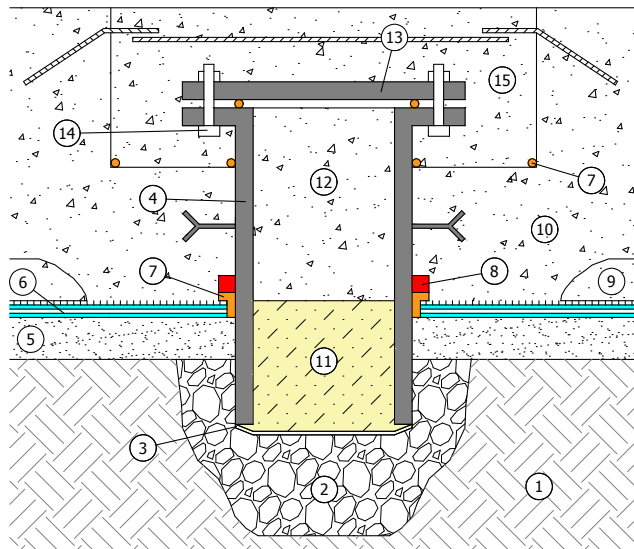

F1/F2

Dewatering well with Delta Amphibia

1. Soil
2. Drainage area
3. Non-woven textile + net
4. Flanged pipe with clamp-irons (stainless or galvanised)
5. Lean concrete
6. Delta Amphibia
7. Delta Amphibia AKTI-VO 201
8. Delta Amphibia WT Range (hydro-expansive waterstop)
9. Protective screed (optional)
10. RC raft foundation suitable to withstand hydraulic pressures and exempt from defects
11. Granular bentonite
12. Cast-in-place concrete to fill the well
13. Stainless steel cap sealed with Delta Amphibia AKTI-VO 201
14. Welded bolts
15. Cast-in-place concrete to fill the void on the raft

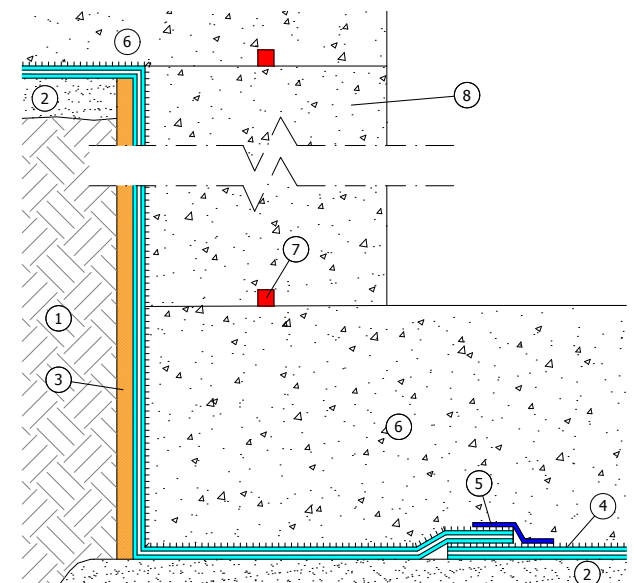
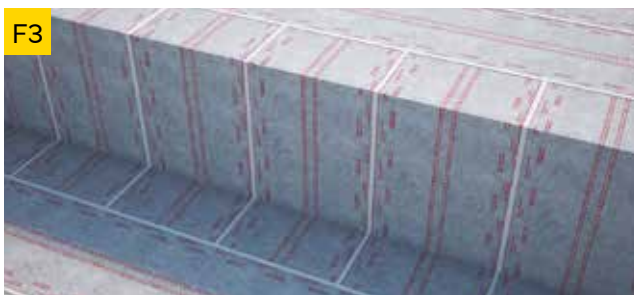

F3

Raft foundations at different heights

1. Soil
2. Lean concrete
3. Disposable formwork or lean concrete
4. Delta Amphibia
5. Delta Amphibia safety tape or Delta Amphibia BI-Mastic
6. RC raft foundation suitable to withstand hydraulic pressures and exempt from defects
7. Delta Amphibia WT Range (hydro-expansive waterstop)
8. RC wall suitable to withstand hydraulic pressures and exempt from defects

APPLICATION

5.5 Sheet application

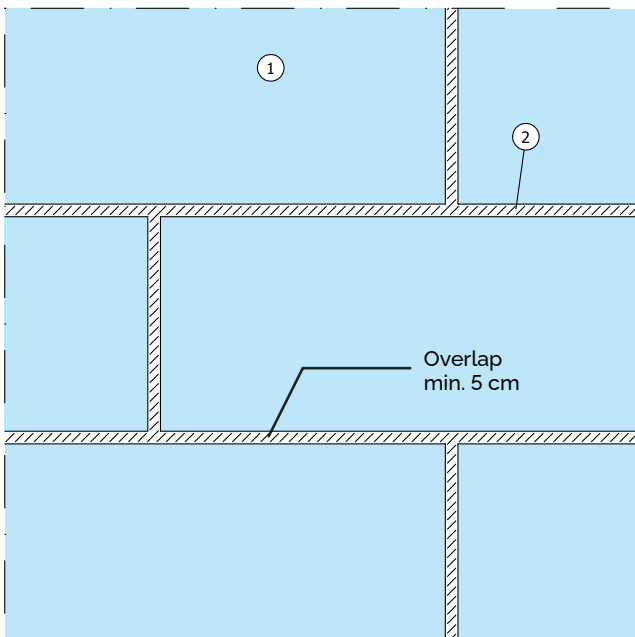
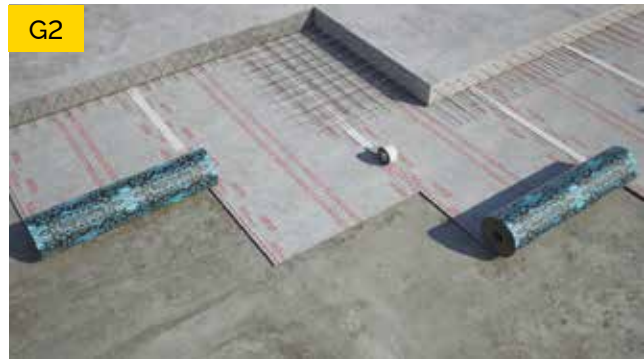

G1/G2

Delta Amphibia installation pattern type

1. Delta Amphibia
2. Delta Amphibia Safety Tape or Delta Amphibia BI-Mastic

Raft foundation with Delta Amphibia system



APPLICATION

5.6 Joints in Raft Foundation

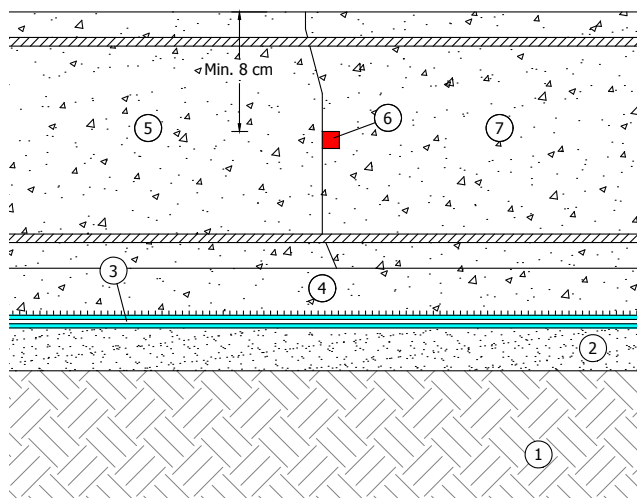
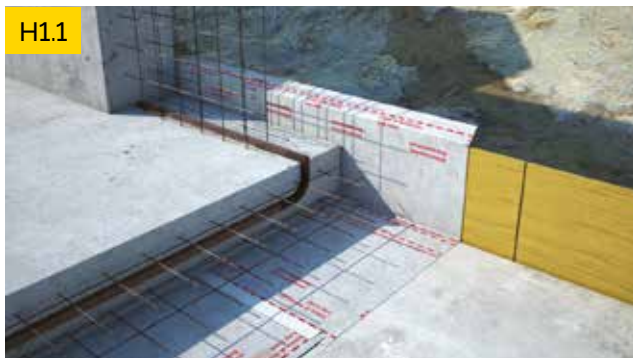

H1.1/H1.2

Horizontal construction joint (cold joint) - raft foundation with Delta Amphibia

1. Soil
2. Lean concrete
3. Delta Amphibia
4. Concrete protective screed (optional)
5. First part of the RC raft foundation suitable to withstand hydraulic pressures and exempt from defects
6. Delta Amphibia WT Range (hydro-expansive waterstop)
7. Second part of the RC raft foundation suitable to withstand hydraulic pressures and exempt from defects

Detail of Delta Amphibia WT Waterstop Range

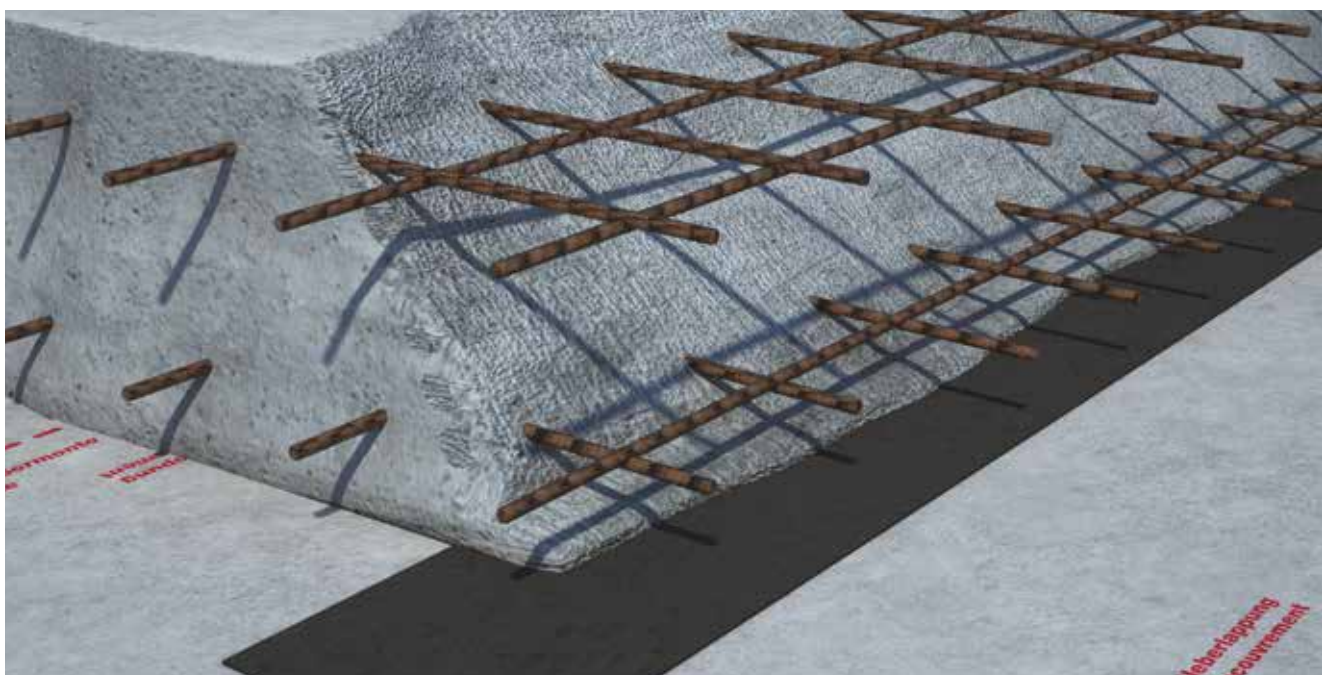

APPLICATION

5.7 Joints in Raft Foundation - Expansion Joints

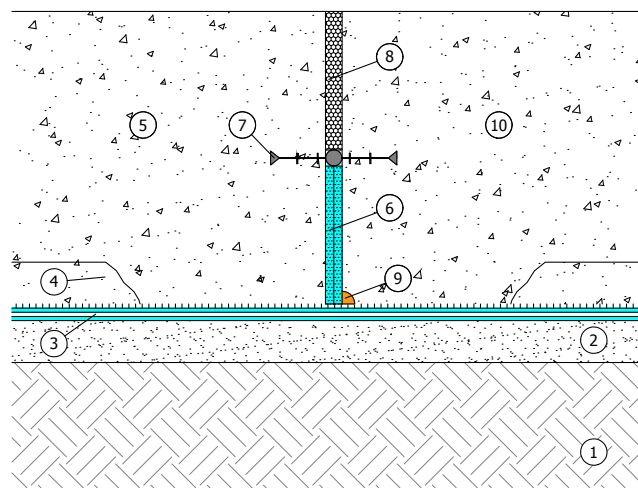

H2.1

RC raft foundation with Delta Amphibia - expansion joint with PVC waterstop

1. Soil
2. Lean concrete
3. Delta Amphibia
4. Concrete protective screed (optional)
5. First part of the RC raft foundation suitable to withstand hydraulic pressures and exempt from defects.
6. Joint Panel Type T (multiples)
7. PVC waterstop
8. Separating element
9. Delta Amphibia AKTI-VO 201
10. Second part of the RC raft foundation suitable to withstand hydraulic pressures and exempt from defects

APPLICATION

5.8 Vertical application on formworks

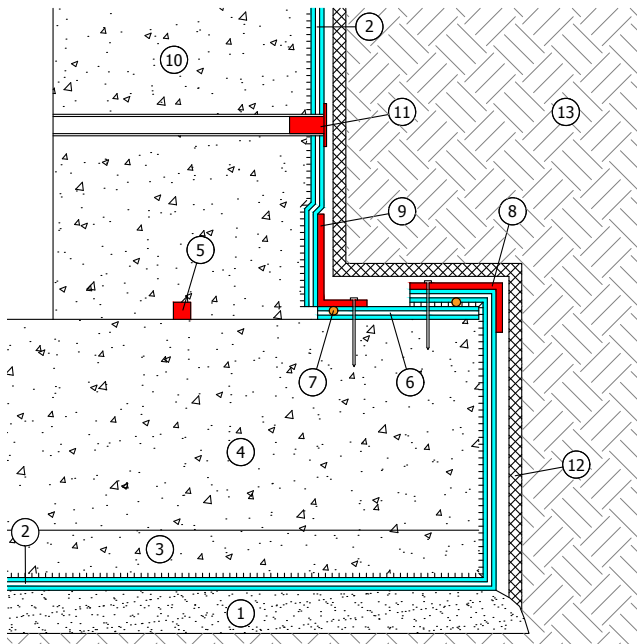

i1/i2/i3.

Construction joint with Delta Amphibia pre-applied on formworks with toe

1. Lean concrete
2. Delta Amphibia
3. Concrete protective screed (optional)
4. RC raft foundation suitable to withstand hydraulic pressures and exempt from defects
5. Delta Amphibia WT Range (hydro-expansive waterstop)
6. Delta Amphibia
7. Delta Amphibia BI-Mastic or Delta Amphibia AKTI-VO 201
8. Delta Amphibia Pressure Corner 90°
9. Delta Amphibia Pressure Corner 270°
10. RC wall suitable to withstand hydraulic pressures and exempt from defects
11. Delta Amphibia Stopper with Delta Amphibia AKTI-VO 201 to seal the distance tube
12. Rigid insulation panels or non-woven textile min 250 g/m²
13. Well compacted soil without voids

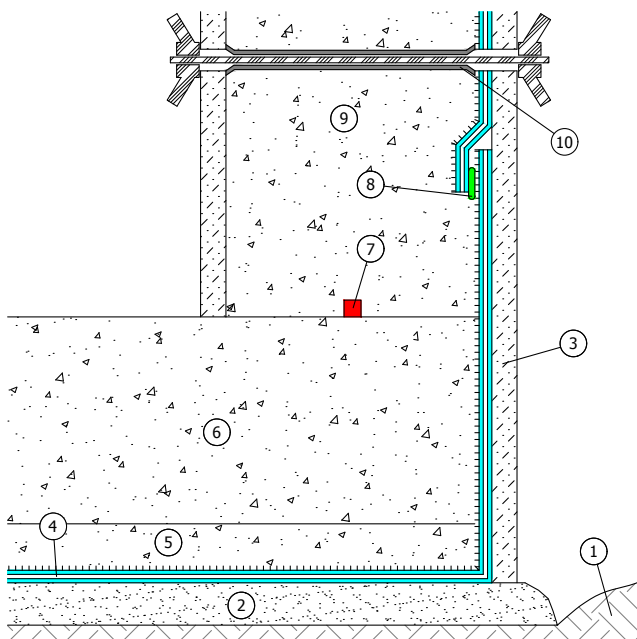

Construction joint with Delta Amphibia pre-applied on formworks without toe

1. Soil
2. Lean concrete
3. Formwork
4. Delta Amphibia
5. Concrete protective screed (optional)
6. RC raft foundation suitable to withstand hydraulic pressures and exempt from defects
7. Delta Amphibia WT Range (hydro-expansive waterstop)
8. Overlaps fixed by stapling and/or with Delta Amphibia BI-Mastic
9. RC wall suitable to withstand hydraulic pressures and exempt from defects
10. Distance tube to seal consequently with Delta Amphibia Stopper and Delta Amphibia AKTI-VO 201

APPLICATION

5.9 Vertical application on diaphragm walls

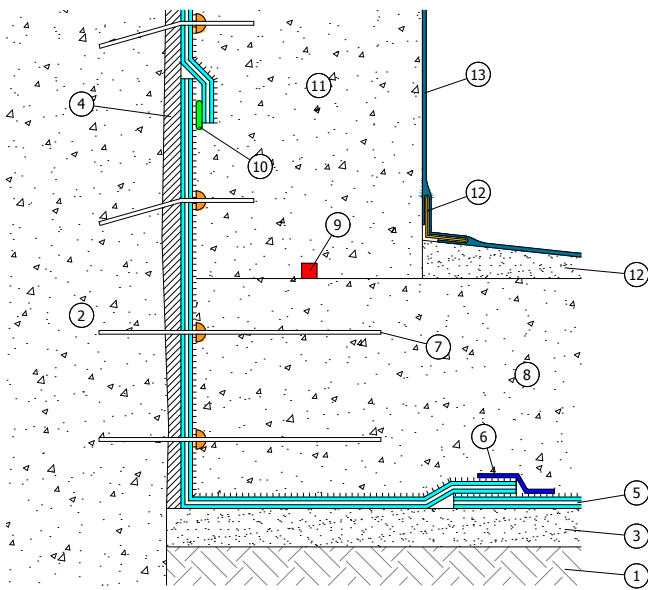

J1/J2/J3/J4

Light shaft" shaft with Delta Amphibia and plastivo

1. Soil
2. Diaphragm wall
3. Lean concrete
4. Suitable smoothing or non-degradable rigid panel
5. Delta Amphibia
6. Delta Amphibia Safety Tape or Delta Amphibia BI-Mastic
7. Connectors sealed with Delta Amphibia AKTI-VO 201
8. RC raft foundation suitable to withstand hydraulic pressures and exempt from defects
9. Delta Amphibia WT Range (hydro-expansive waterstop)
10. Delta Amphibia BI-Mastic
11. RC wall suitable to withstand hydraulic pressures and exempt from defects
12. Koster Repair Mortar Plus
13. Koster Koster NB1

Application of Delta Amphibia system on regularized diaphragm walls



APPLICATION

5.10 Vertical application on metal sheet piling

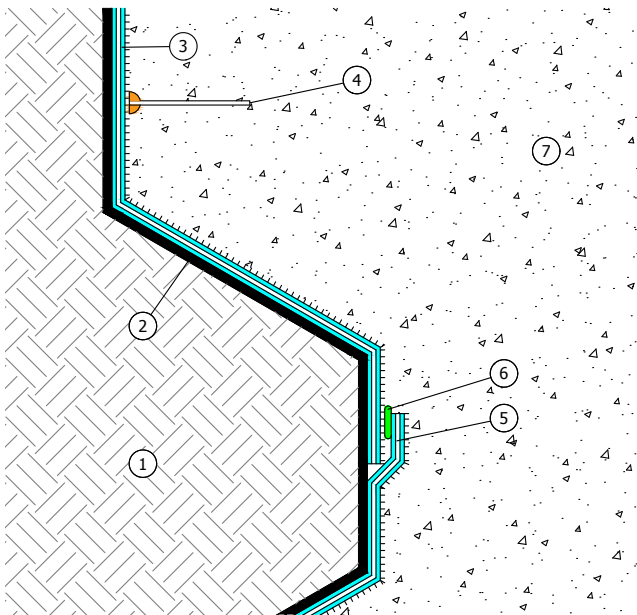

K1/K2/K3

Disposable metal sheet piles with Delta Amphibia

1. Soil
2. Metal sheet piles
3. Delta Amphibia
4. Connectors sealed with Delta Amphibia AKTI-VO 201 (optional, in accordance with the Designer's choice)
5. Overlap sealed with nail gun
6. Delta Amphibia BI-Mastic
7. RC structure suitable to withstand hydraulic pressures and exempt from defects

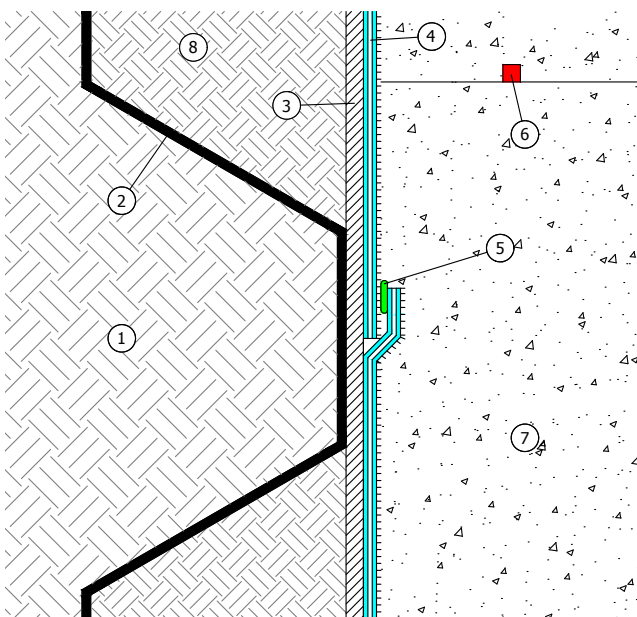

Recoverable metal sheet piles with Delta Amphibia

1. Soil
2. Recoverable metal sheet piles
3. Non-degradable rigid panel
4. Delta Amphibia
5. Overlap fixed with Delta Amphibia BI-Mastic
6. Delta Amphibia WT Range (hydro-expansive waterstop)
7. RC structure suitable to withstand hydraulic pressures and exempt from defects
8. Well compacted soil without voids

APPLICATION

5.11 Vertical application on pile walls

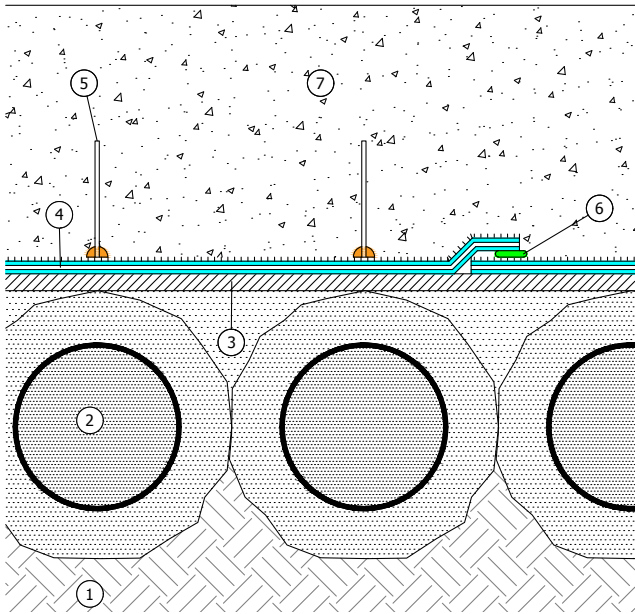

L1/L2/L3/L4

Micropiles with Delta Amphibia

1. Soil
2. Micropiles
3. Smoothing or non-degradable rigid panel
4. Delta Amphibia
5. Connectors sealed with Delta Amphibia AKTI-VO 201
6. Delta Amphibia BI-Mastic
7. RC structure suitable to withstand hydraulic pressures and exempt from defects

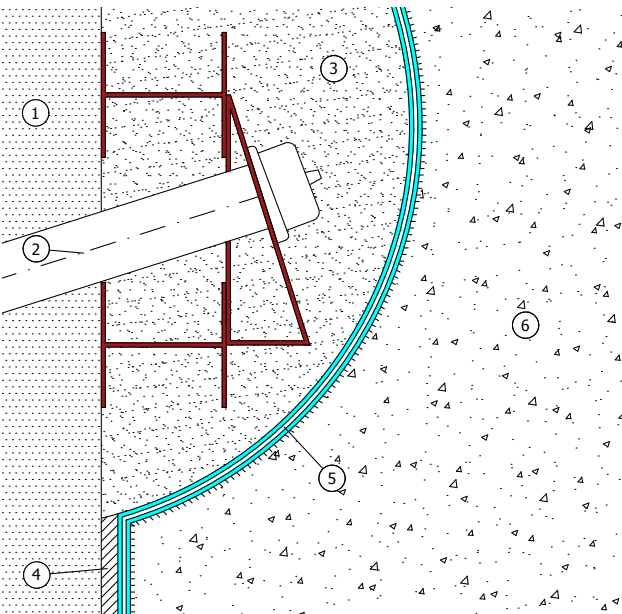

Delta Amphibia with anchored piling

1. Piling
2. Tieback anchor
3. Smoothing
4. Smoothing or non-degradable rigid panel
5. Delta Amphibia
6. RC structure suitable to withstand hydraulic pressures and exempt from defects

APPLICATION

5.12 Joints in retaining walls

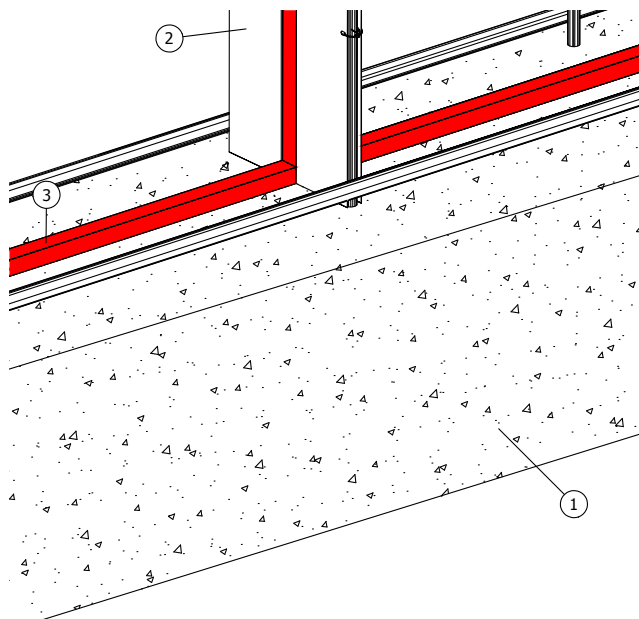

CONSTRUCTION JOINTS AND STRUCTURAL CRACK INDUCER

M1.1./M1.2 BREAK

1. RC structure suitable to withstand hydraulic pressures and exempt from defects
2. BREAK
3. Delta Amphibia WT Range (hydro-expansive waterstop)

Application of self-sealing structural crack inducer BREAK



APPLICATION

5.13 Slab sealing in blindside installation

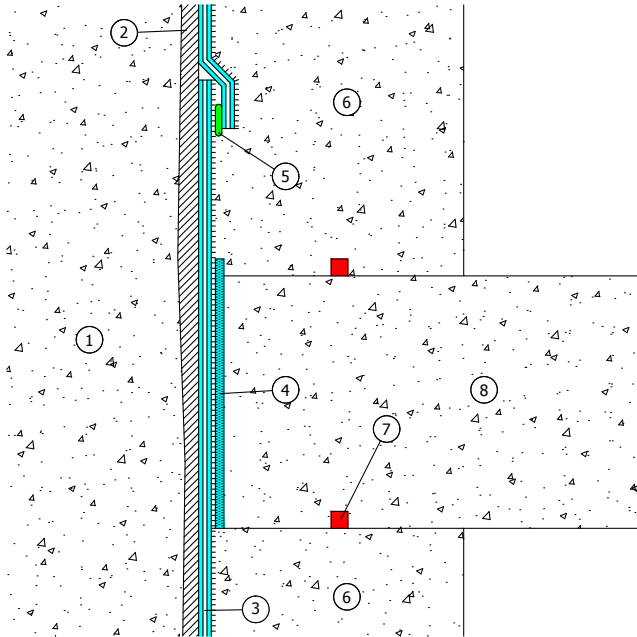
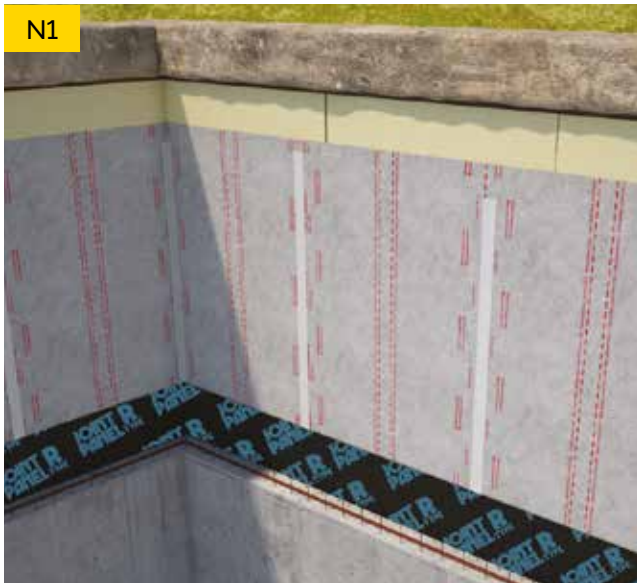

N1/N2

Intermediate Slab Against Diaphragm Wall

1. Diaphragm walls
2. Smoothing or non-degradable rigid panel
3. Delta Amphibia
4. Joint Panel type R (*) or double Joint Panel type R glued/ fixed (on Delta Amphibia) and with their adjacent edges sealed with Delta Amphibia BI-Mastic/ AKTI-VO 201
5. Delta Amphibia BI-Mastic
6. RC wall suitable to withstand hydraulic pressures and exempt from defects
7. Delta Amphibia Delta Amphibia WT Range (hydro-expansive waterstop)
8. Intermediate slab

Application of hydro-expanding rubber joint panel type R for concrete slab sealing



SERVICE PENETRATIONS

6.1 Sealing of penetration

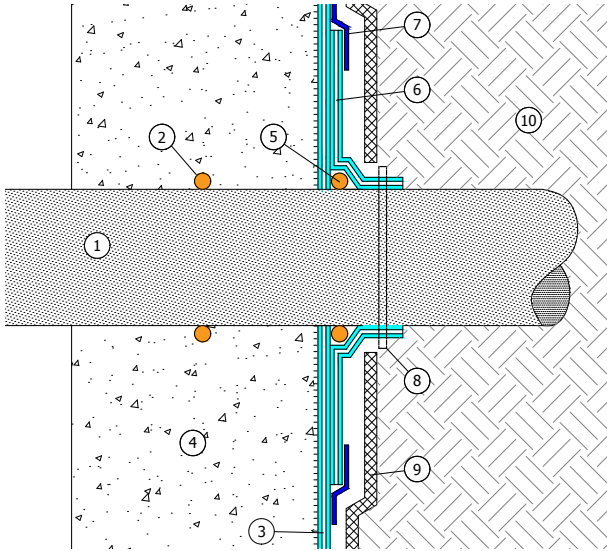

O1.1/O1.2

Delta Amphibia membrane pre-applied installation - sealing of penetrations

1. Penetration (pre-applied installation)
2. Delta Amphibia AKTI-VO 201 already crystallized before pouring concrete
3. Delta Amphibia
4. RC structure suitable to withstand hydraulic pressures and exempt from defects
5. Delta Amphibia AKTI-VO 201 after casting concrete
6. Delta Amphibia patch all around the penetration
7. Delta Amphibia Safety Tape and/or Delta Amphibia BI-Mastic
8. Hose clamp
9. Rigid insulation panels or non-woven textile min. 250 g/m2)
- 10.

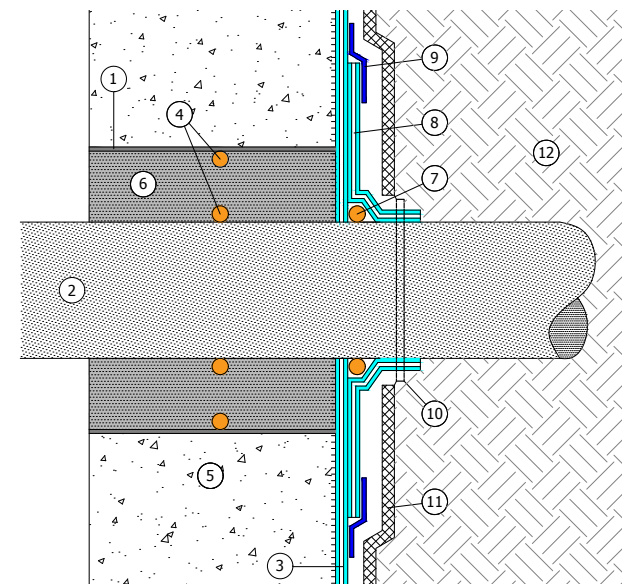

O1.3/O1.4

Delta Amphibia membrane pre-applied installation - sealing penetrations with pipe sleeve

1. Pipe sleeve installed before pouring concrete
2. Penetration
3. Delta Amphibia
4. Delta Amphibia AKTI-VO 201 already crystallised before pouring concrete
5. RC structure suitable to withstand hydraulic pressures and exempt from defects
6. Filling with Koster Repair Mortar Plus
7. Delta Amphibia AKTI-VO 201
8. Delta Amphibia patch installed all around the penetration
9. Delta Amphibia Safety Tape and/or Delta Amphibia BI-Mastic
10. Hose clamp
11. Rigid non-degradable insulation panel or non-woven textile (min 250 g/m2)
12. Well compacted soil without voids

SERVICE PENETRATIONS

6.2 Sealing of penetrations

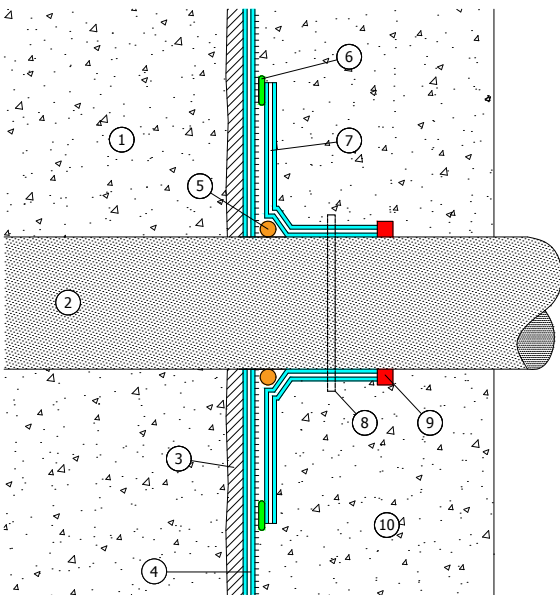
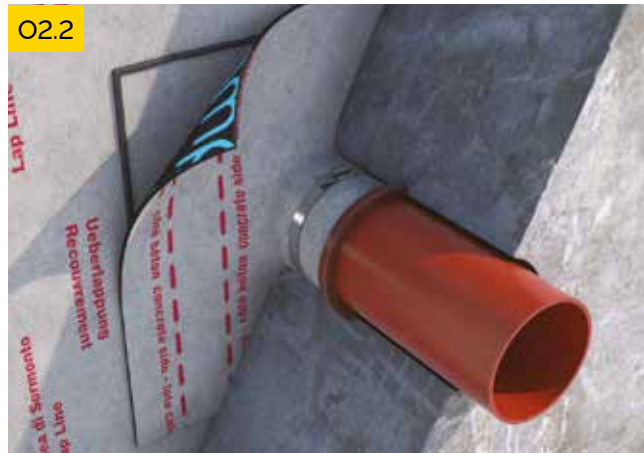
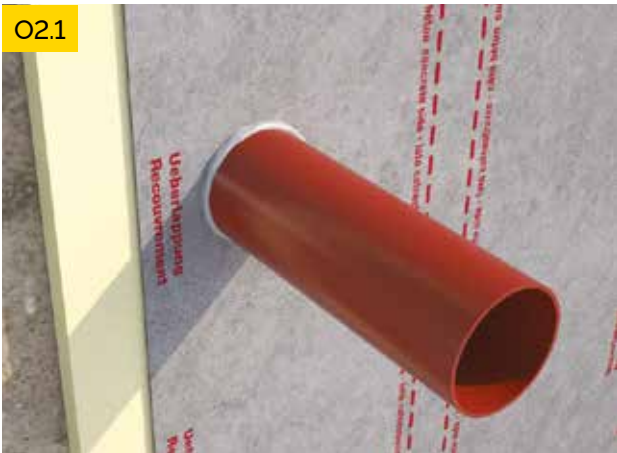

O2.1/O2.2

Delta Amphibia installed on slurry walls/existing structures- sealing of penetrations

1. Slurry wall/Existing structure
2. Penetration (pre-applied installation)
3. Smoothing or rigid non-degradable panels
4. Delta Amphibia
5. Delta Amphibia AKTI-VO 201
6. Delta Amphibia BI-Mastic
7. Delta Amphibia patch installed all around the penetration
8. Hose clamp
9. Delta Amphibia Delta Amphibia WT Range (hydro-expansive waterstop)
10. RC structure suitable to withstand hydraulic pressures and exempt from defects

Sealing penetration with hydro-expanding mastic and Delta Amphibia system



SERVICE PENETRATIONS

6.3 Connections and sealing details

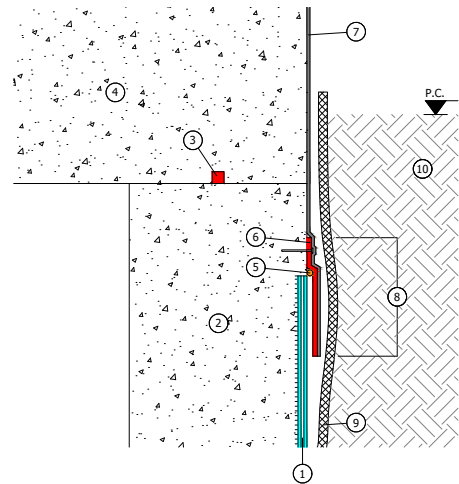
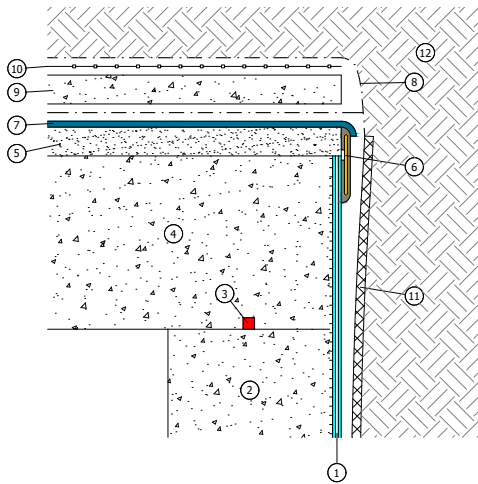
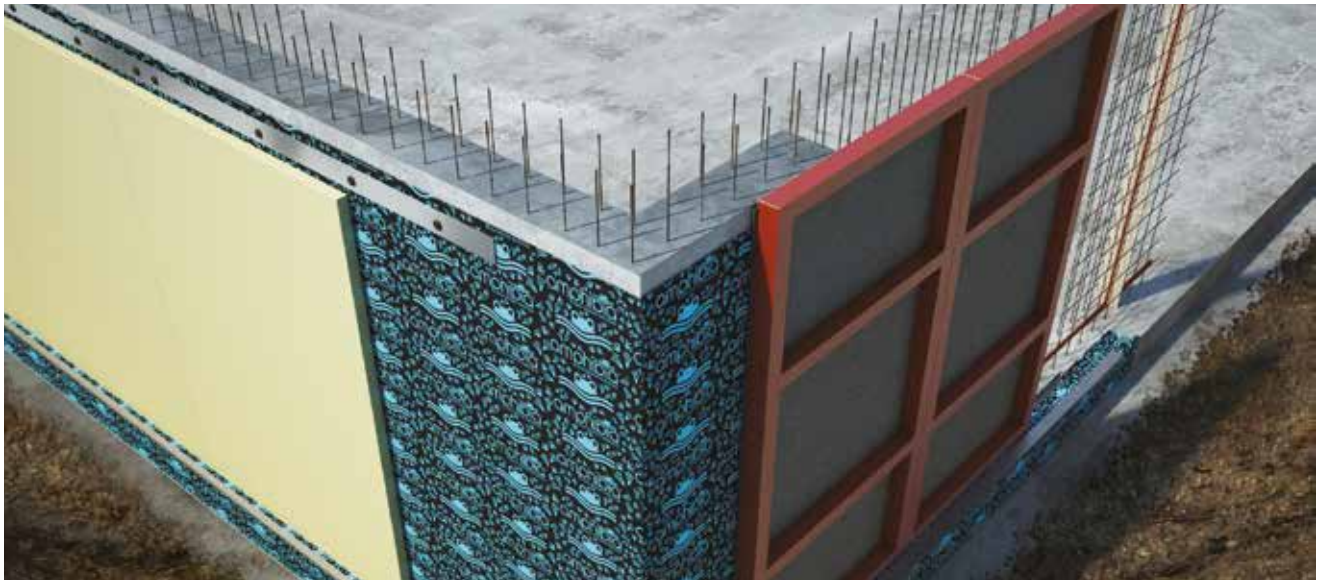

Connection between Delta Amphibia and Delta/Koster Waterproofing Systems

1. Delta Amphibia
2. RC wall suitable to withstand hydraulic pressures and exempt from defects
3. Delta Amphibia Delta Amphibia WT Range (hydro-expansive waterstop)
4. RC roof slab
5. Concrete sloped screed
6. Delta Amphibia Pressure Line
7. Koster NB4000 / Deuxan 2C
8. Separating protective element
9. Concrete protective screed
10. Suitable drainage system
11. Rigid non-degradable insulation panels or non-woven textile (min 250 g/m²)
12. Well compacted soil without voids

Connection between Delta Amphibia and bituminous waterproofing membranes

1. Delta Amphibia
2. RC wall suitable to withstand hydraulic pressures and exempt from defects
3. Delta Amphibia Delta Amphibia WT Range (hydro-expansive waterstop)
4. RC roof slab
5. Delta Amphibia AKTI-VO 201
6. Zinc-coated metal flashing (min 20 cm)
7. Bituminous waterproofing membrane
8. Part of bituminous waterproofing sheetmembrane to be torched onto the metal flashing
9. Rigid non-degradable insulation panels or non-woven textile (min 250 g/m²)
10. Well compacted soil without voids

7. Maintenance

Type A waterproofing solutions, if applied correctly on first installation do not require ongoing or routine maintenance.

8. Patch Repair during installation

Where Delta Amphibia is mechanically damaged then a simple patch repair can be carried out, cut a section of Delta Amphibia so as there is a minimum 100mm overlap to the damaged area and seal patch on to existing Delta Amphibia membrane using Delta Bi-Mastic.

9. Inspection/Quality Control

Delta Amphibia should only be installed by a competent trained contractor.

We recommend the membrane installation contractors record all relevant details and facts in a written record to provide a reference for the installation.

See section 14 for Site Installation Log.

10. Health and Safety

10.1 - For the installation of Delta Amphibia, there is no special personal protection equipment (PPE) or safety equipment required. In order to minimise the risk of ill health or accidents when installing the Delta Amphibia system workers must be fully trained, competent and follow health and safety guidelines.

PPE should be provided to workers who might be exposed to anything that could risk their health and safety while on site. As a minimum, most construction site will require some form of head protection, a high vis vest or jacket, and suitable footwear. Exact details will vary on each construction site and Coshh requirements.

10.2 - The generation of waste should be avoided and/or minimalised wherever possible. Any waste from the installation of Delta Amphibia system should be disposed of in accordance with local regulations.

11. Warranty/Guarantees

Delta Membrane Systems Limited offer a 20-year Product Guarantee on membranes, seals, and fixings when the Delta Amphibia waterproofing solution has been installed by a Delta Registered Installer.

A list of experienced Delta Registered Installers is available from Delta's offices.

12. Troubleshooting

Please contact Delta Membranes on 01992 523 523 between 8 am and 5 pm Monday to Friday or by email at info@deltamembranes.com for more information.

13. Ancillaries

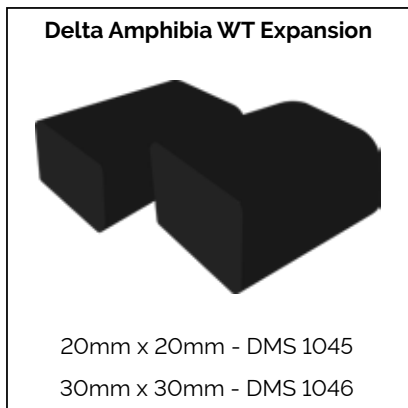
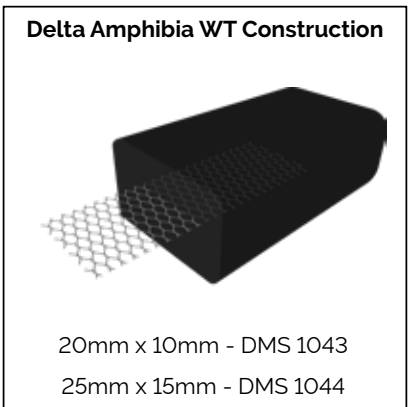

TECHNICAL DRAWINGS

15. Technical Drawings

15.1 Delta Amphibia - Level Change Raft Slab Detail

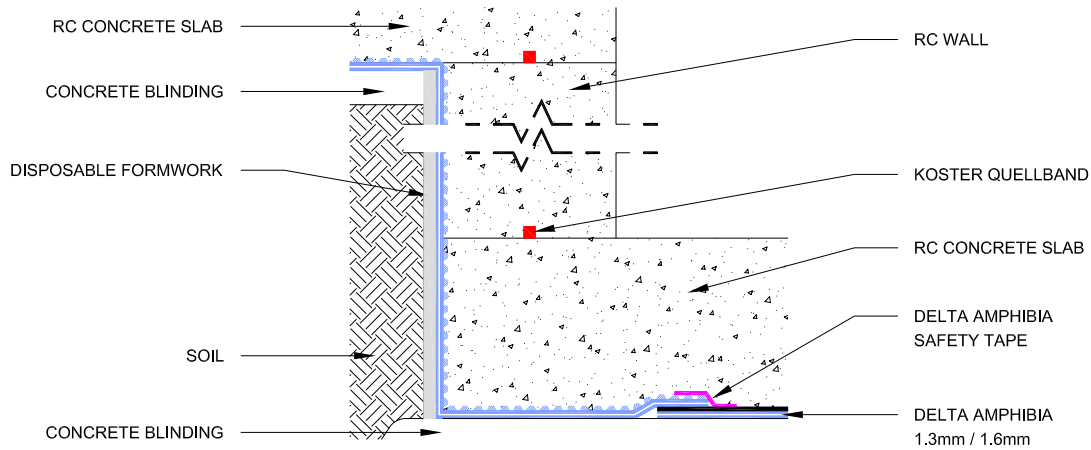

15.2 Delta Amphibia - Wall/Floor Detail, Diaphragm / Piled Wall

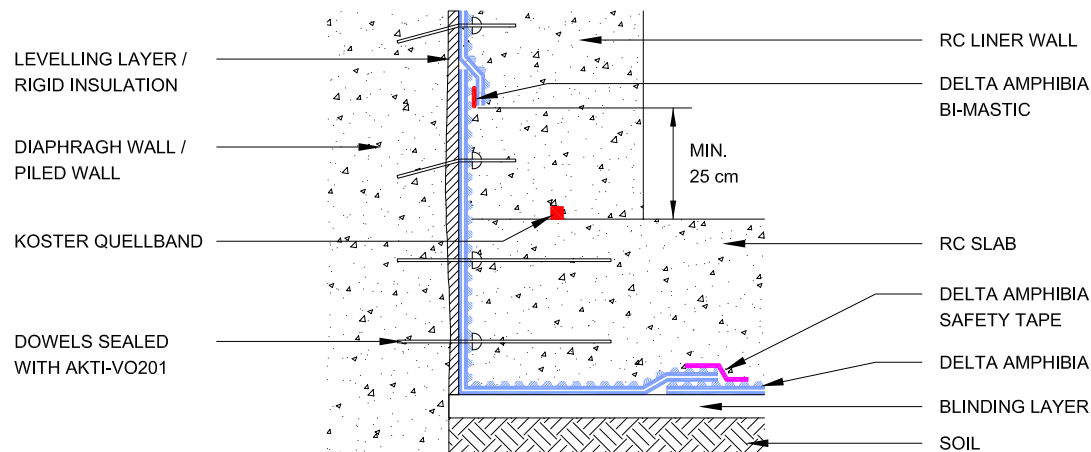

15.3 Delta Amphibia - Sheet Piles

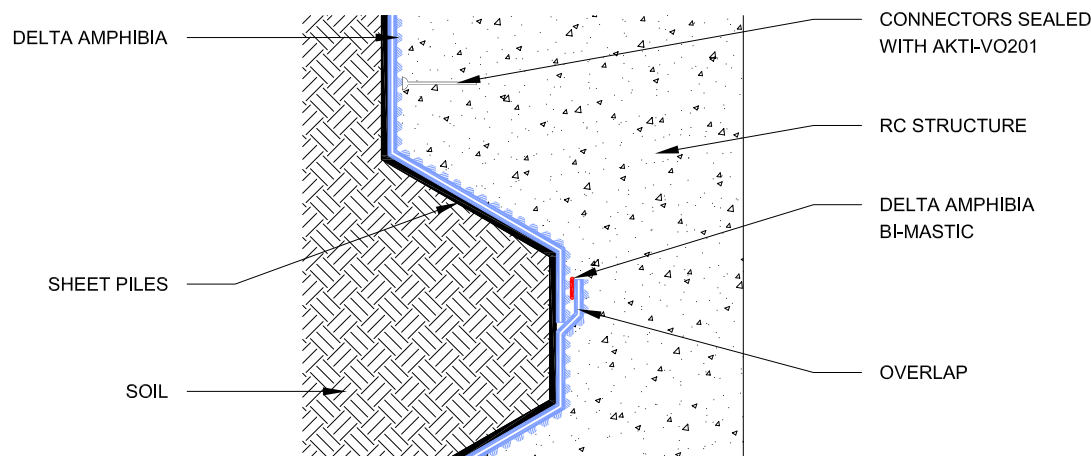

15. Technical Drawings

15.4 Delta Amphibia - Wall / Slab Detail with Toe

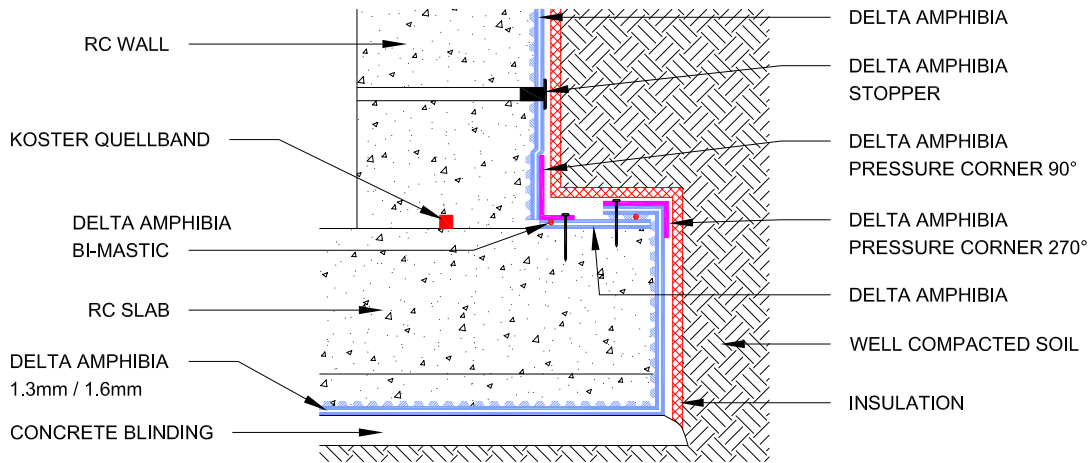

15.5 Delta Amphibia - Wall / Slab Detail Toeless Construction

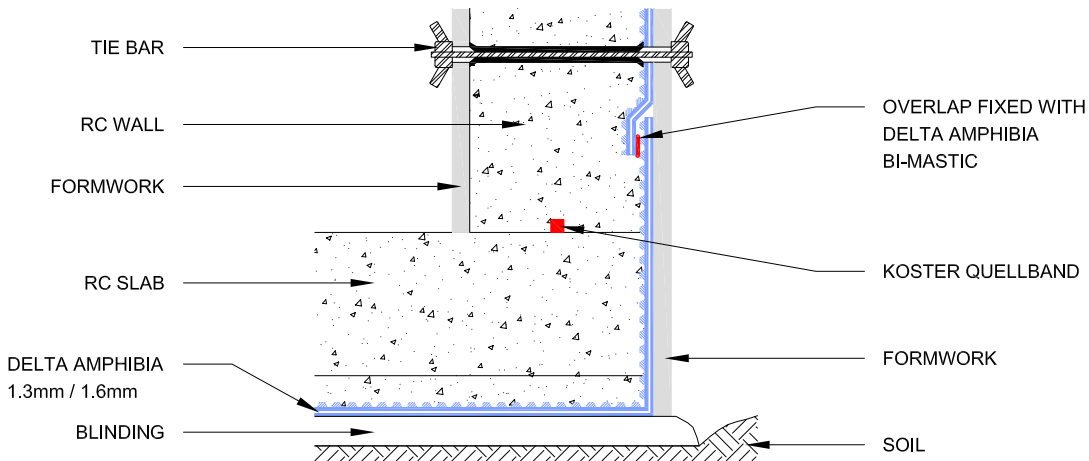

15.3 Delta Amphibia - Horizontal Construction Joint, Raft Slab

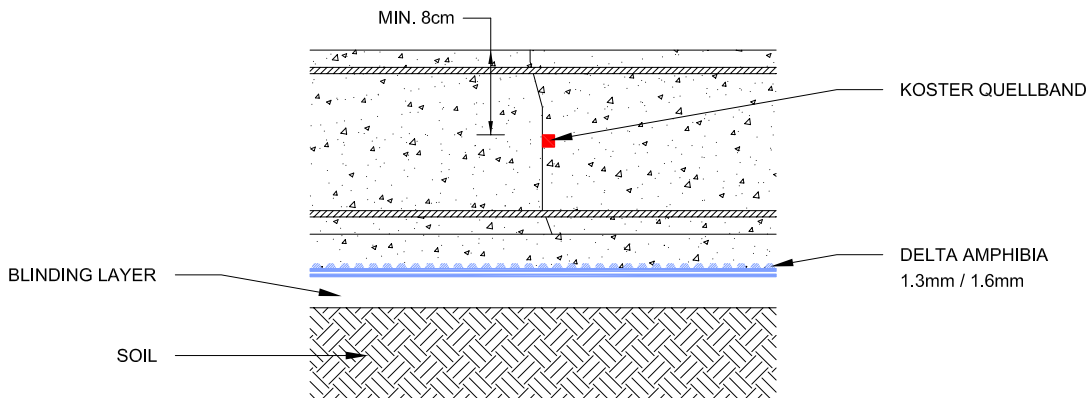

15. Technical Drawings

15.6 Delta Amphibia - Internal 90° Corner Detail

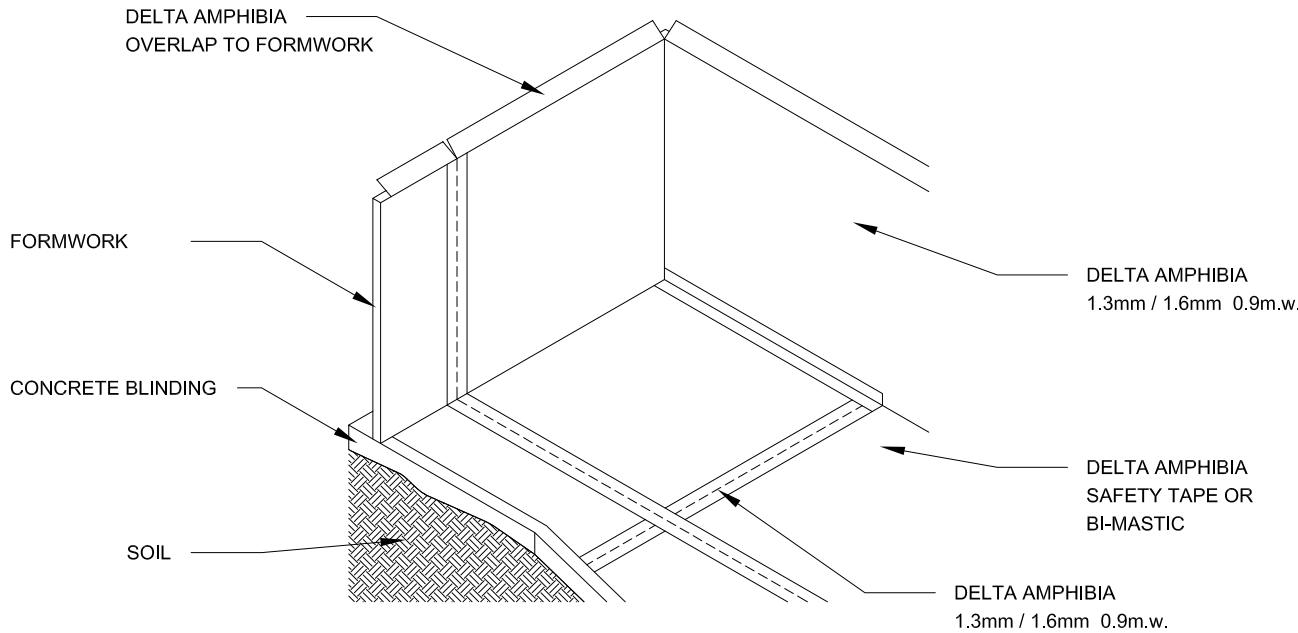

15.6 Delta Amphibia - Internal 270° Corner Detail

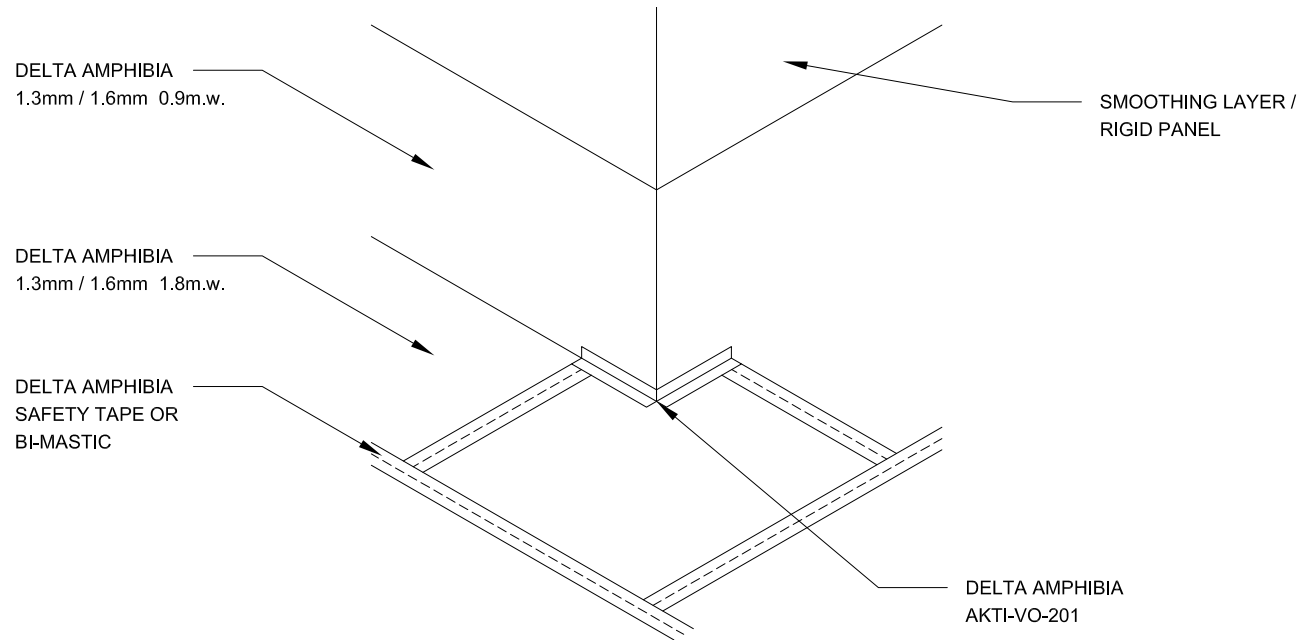

Delta Membrane Systems Ltd, Delta House, Merlin Way, North Weald, Epping, Essex, CM16 6HR.

01992 523 523 info@deltamembranes.com www.deltamembranes.com

 [deltamembranes](#)  [deltamembranes](#)  [delta-membrane-systems-ltd](#)  [deltamembranesystems](#)